

**Fitting for 1-2 top-running wooden doors up to 36 kg (79 lbs.), with groove mounted running track. With soft and self closing mechanism. Design Inside.**

**Product highlights**

- Aesthetics** Optimum solution for serving hatches thanks to the lateral, concealed running system
- Flexibility** Wide range of applications for sliding door cabinets in any dimension

**Technical specifications**

- Max. 36 kg (79 lbs.)
- Max. 2400 mm (7'10 7/16")
- Max. 1000 mm (3'3 3/8")
- 19-40 mm (3/4" to 1 9/16")

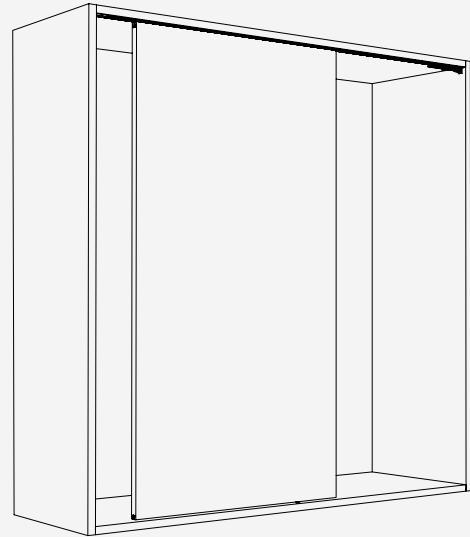

**Installation examples**

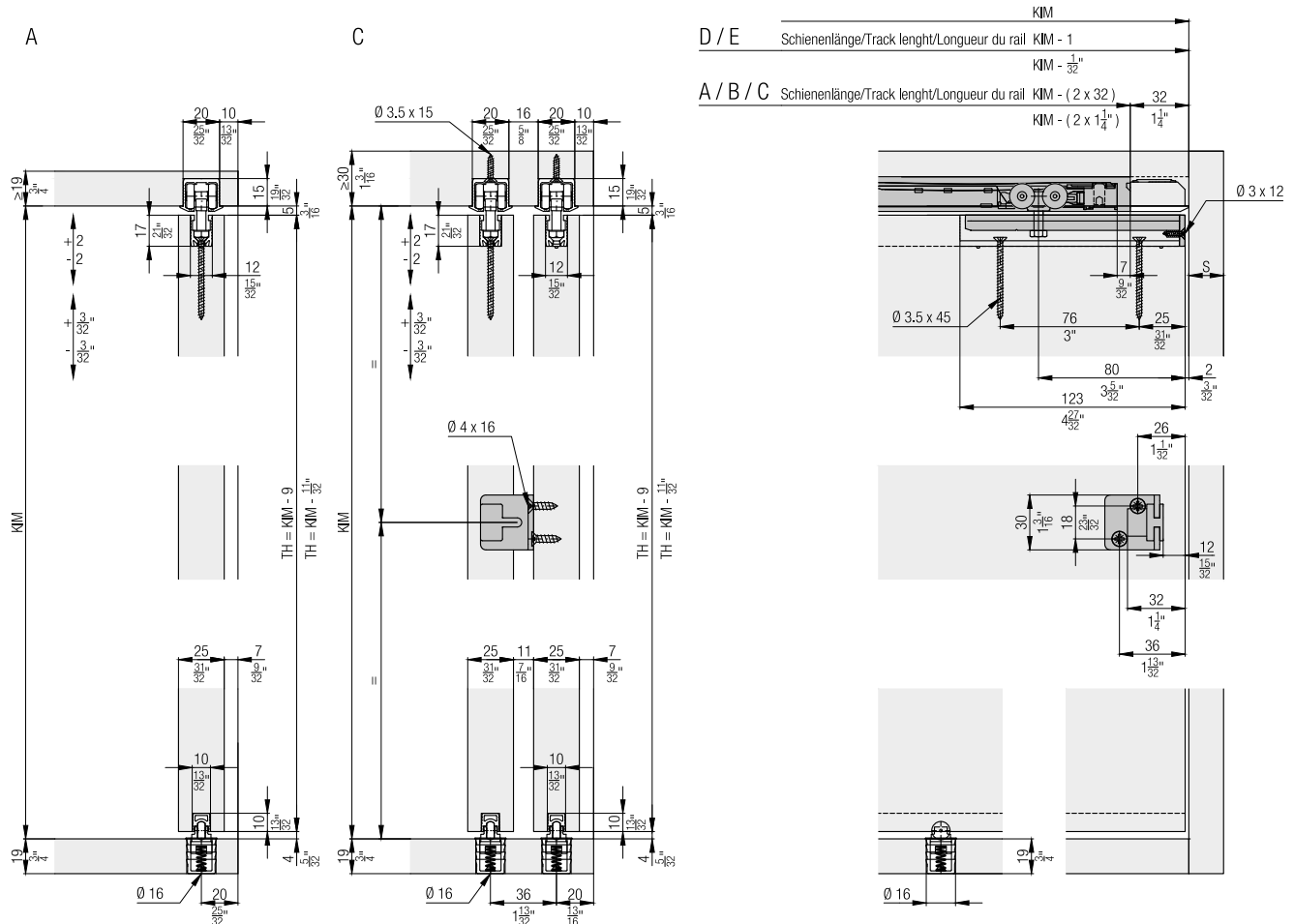





Subject to technical modifications. Metric specifications are exact. Inches are approximate.

**Set for 1 wooden door up to 36 kg (79 lbs.), with height adjustment**  
**Always order 2 sets with 2 doors.**

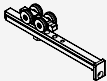
|                                 | No.          |
|---------------------------------|--------------|
| Hawa Clipo 36 HM IS, for 1 door | 053.3358.071 |

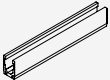
**Set consisting of:**



|   |   | 053.3358.071 | No.          |
|---|---|--------------|--------------|
|    | Running gear  | 2            | 053.3343.071 |
|    | Flat countersunk head chipboard screw, 3x12 mm (1/8 "x 15/32"), steel, zinc-plated, black | 2            | 600.0000.703 |
|    | Stopper, plastic, gray  | 2            | 057.3148.071 |
|   | Housing, aluminum   | 2            | 053.3073.007 |
|  | Flat countersunk head chipboard screw 3.5x45 mm (5/32"x1 25/32"), steel, zinc-plated      | 4            | 600.0000.706 |
|  | Bottom guide, plastic, gray   | 1            | 055.3081.071 |

**Door follower**

**Order 1 set with 2 doors.**

|   | No.          |
|---|--------------|
| Door follower, steel, zinc-plated, with 2 doors | 055.3124.071 |

**Set consisting of:**

|   |  | 055.3124.071 | No.          |
|---|--|--------------|--------------|
|  | Follower Hawa Combino/ Hawa Clipo, plastic                                     | 1            | 055.3123.071 |
|  | Adapter to follower steel, zinc-plated   | 1            | 055.0213.101 |
|  | Flat countersunk head chipboard screw 4x16 mm (5/32"x5/8"), steel, zinc-plated | 2            | 600.0000.253 |

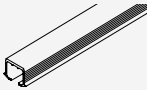
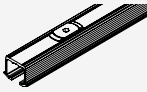
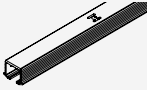
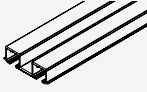
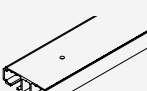

**Running tracks**

|   |   | mm (inch)            | No.          |
|---|---|----------------------|--------------|
|    | A: Single running track, for glue fixing, aluminum, anodized  | 2,500 (8' 2 7/16")   | 053.3324.250 |
|   |   | 3,500 (11' 5 25/32") | 053.3324.350 |
|   |   | 6,000 (19' 8 7/32")  | 053.3324.600 |
|    | B: Single running track, swivel lug, aluminum, anodized (not for hard wood/ MDF)                    | 2,500 (8' 2 7/16")   | 053.3327.250 |
|   |   | 3,500 (11' 5 25/32") | 053.3327.350 |
|   |   | 6,000 (19' 8 7/32")  | 053.3327.600 |
|    | C: Single running track, for screw fixing, aluminum, anodized                                       | 2,500 (8' 2 7/16")   | 053.3325.250 |
|   |   | 3,500 (11' 5 25/32") | 053.3325.350 |
|   |   | 6,000 (19' 8 7/32")  | 053.3325.600 |
|  | D: Double running track, for screw fixing, aluminum, anodized, for door thickness of 25 mm (31/32") | 2,500 (8' 2 7/16")   | 053.3328.250 |
|   |   | 3,500 (11' 5 25/32") | 053.3328.350 |
|   |   | 6,000 (19' 8 7/32")  | 053.3328.600 |
|  | E: Double running track, for screw fixing, aluminum, anodized, for door thickness of 19 mm (3/4")   | 2,500 (8' 2 7/16")   | 053.3339.250 |
|   |   | 3,500 (11' 5 25/32") | 053.3339.350 |
|   |   | 6,000 (19' 8 7/32")  | 053.3339.600 |

**Track end piece set for single running tracks**

|   | No.          |
|---|--------------|
| Track-end section, for screw fixing, plastic, gray, 2-piece set | 053.3354.071 |
| Track-end section, swivel lug, plastic, gray, 2-piece set       | 053.3355.051 |

**Set consisting of:**

|   | 053.3354.071 | 053.3355.051 | No.          |
|---|--------------|--------------|--------------|
|  Track-end piece, for screw fixing, plastic                  | 2            |              | 053.0334.001 |
|  Chipboard screw, 4x12 mm (5/32"x15/32"), steel, zinc-plated | 2            |              | 600.0000.704 |
|  Track-end piece, with swivel lug, plastic                   |              | 2            | 053.3351.071 |



**Guide tracks**

|   | mm (inch)            | No.          |
|---|----------------------|--------------|
|  | 2,500 (8' 2 7/16")   | 055.3171.250 |
|   | 3,500 (11' 5 25/32") | 055.3171.350 |
|   | 6,000 (19' 8 7/32")  | 055.3171.600 |

**Soft close up to 15/26/36 kg (33/57/79 lbs.)**

|                                   | No.          |
|-----------------------------------|--------------|
| Soft close, up to 15 kg (33 lbs.) | 057.3159.071 |
| Soft close, up to 26 kg (57 lbs.) | 057.3159.072 |
| Soft close, up to 40 kg (88 lbs.) | 057.3159.073 |

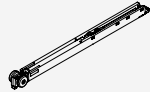
**Set consisting of:**

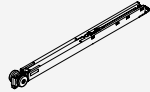
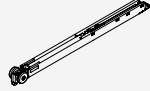
|  | 057.3159.071 | 057.3159.072 | 057.3159.073 | No.          |
|--|--------------|--------------|--------------|--------------|
|  Soft close, up to 15 kg (33 lbs.)  | 2            |              |              | 057.3156.071 |
|  Release piece soft close   | 2            | 2            | 2            | 057.0182.101 |
|  Thread rolling rounded head screw, M2.5x5 mm (3/32"x3/16"), steel, zinc-plated | 2            | 2            | 2            | 600.0000.764 |
|  Soft close, up to 26 kg (57 lbs.)  |              | 2            |              | 057.3156.072 |
|  Soft close, up to 40 kg (88 lbs.)  |              |              | 2            | 057.3156.073 |

**Guide tracks 4-point guidance**

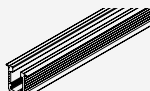

|   | mm (inch)           | No.          |
|---|---------------------|--------------|
|  Single guide track, for glue fixing, aluminum, anodized | 6,000 (19' 8 7/32") | 053.3296.600 |

**Components 4-point guidance**

|   | No.          |
|---|--------------|
|  Bottom guide Hawa Clipo IS/Hawa Regal C 16, plastic, anthracite | 040.3124.071 |
|  Stopper guide track, plastic, grey                              | 053.5094.071 |

**Door centering**

|  | No.          |
|--|--------------|
| Door centering, plastic, anthracite, for 2 doors | 053.3207.071 |

| <b>Set consisting of:</b>   |   | 053.3207.071 | No.          |
|---|---|--------------|--------------|
|  | Housing door centering, plastic, anthracite | 2            | 053.5014.001 |
|  | Pin door centering, plastic, anthracite     | 2            | 053.0171.001 |
|  | Rubber buffer, plastic, grey                | 1            | 025.0107.001 |

**Accessories**

|  | No.                         |              |
|--|-----------------------------|--------------|
|  | Track cleaner, plastic, red | 040.3142.071 |

Further installation examples

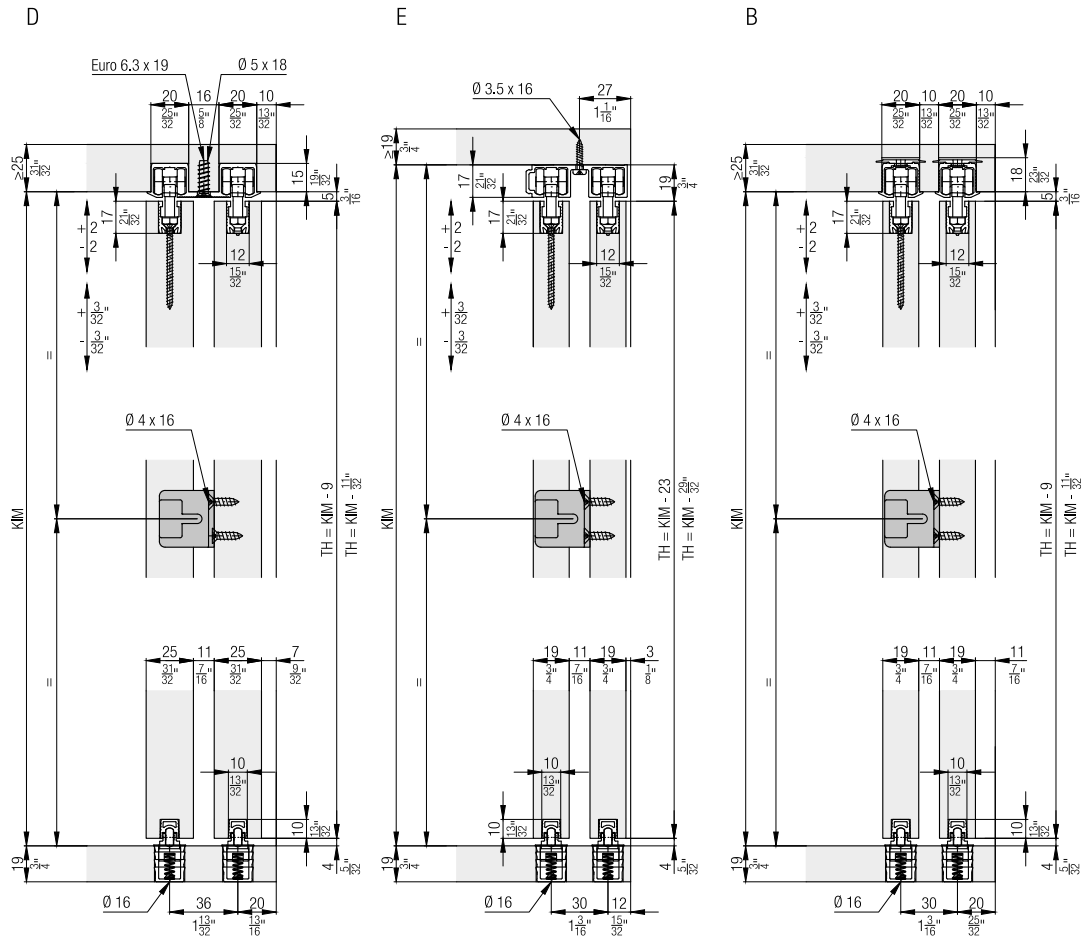

Calculations

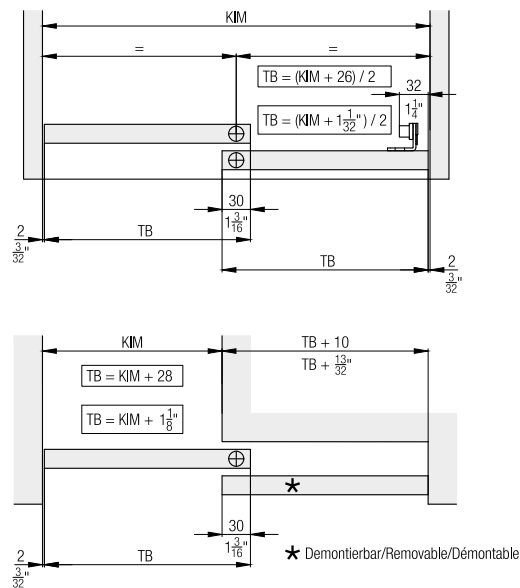

4 point guidance

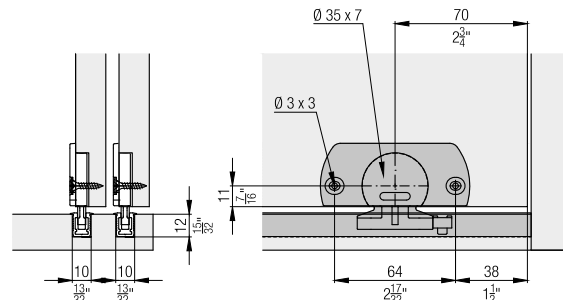

Door centering

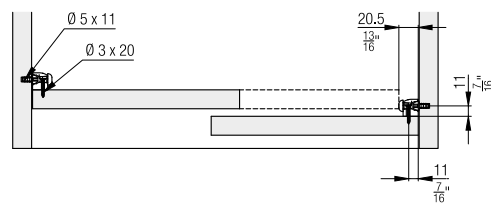

Soft close

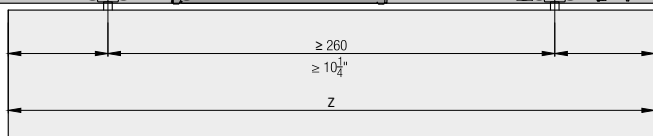

|                       | Z ≥         |              |
|-----------------------|-------------|--------------|
|                       | 1           | 2            |
| Hawa Porta 40 H       | 1' 4 17/32" | 2' 0 13/32"  |
| Hawa Porta 40 GE      | 1' 2 13/16" | 1' 10 11/16" |
| Hawa Clipo 26 H IS    | 1' 4 17/32" | 2' 0 13/32"  |
| Hawa Clipo 26 H MS    | 1' 6 1/32"  | 2' 1 29/32"  |
| Hawa Clipo 36 H IS    | 1' 4 17/32" | 2' 0 13/32"  |
| Hawa Clipo 36 H MS    | 1' 6 1/32"  | 2' 1 29/32"  |
| Hawa Clipo 36 HM IS   | 1' 4 17/32" | 2' 0 13/32"  |
| Hawa Clipo 26 GR IS   | 1' 4 17/32" | 2' 0 13/32"  |
| Hawa Clipo 36 G IS    | 1' 4 17/32" | 2' 0 13/32"  |
| Hawa Clipo 36 GPK IS  | 1' 4 17/32" | 2' 0 13/32"  |
| Hawa Clipo 36 GPPK IS | 1' 4 17/32" | 2' 0 13/32"  |
| Hawa Regal C 26 HM IS | 1' 4 17/32" | 2' 0 13/32"  |
| Hawa Regal C 26 GR IS | 1' 3 3/4"   | 1' 11 5/8"   |

|                       | Z ≥ |     |
|-----------------------|-----|-----|
|                       | 1   | 2   |
| Hawa Porta 40 H       | 420 | 620 |
| Hawa Porta 40 GE      | 376 | 576 |
| Hawa Clipo 26 H IS    | 420 | 620 |
| Hawa Clipo 26 H MS    | 458 | 658 |
| Hawa Clipo 36 H IS    | 420 | 620 |
| Hawa Clipo 36 H MS    | 458 | 658 |
| Hawa Clipo 36 HM IS   | 420 | 620 |
| Hawa Clipo 26 GR IS   | 420 | 620 |
| Hawa Clipo 36 G IS    | 420 | 620 |
| Hawa Clipo 36 GPK IS  | 420 | 620 |
| Hawa Clipo 36 GPPK IS | 420 | 620 |
| Hawa Regal C 26 HM IS | 420 | 620 |
| Hawa Regal C 26 GR IS | 400 | 600 |

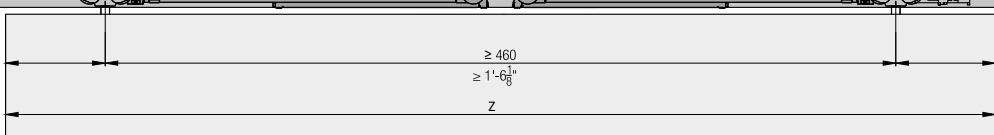

Accessories

– Straightening fitting from page 236

Planning/execution

Further information about the product can be found on [www.hawa.com](http://www.hawa.com).